

# TAKEX FLAME SENSOR WITH SPEAKER

## FS-3500E

### Instruction manual

We appreciate your purchase of TAKEX flame sensor.  
Please read this instruction manual carefully for correct and effective use.

This sensor is designed to detect flames and to initiate an alarm, it is not a fire-preventing device.  
TAKEX is not responsible for damage, injury or losses caused by accident, theft, Acts of God (Including inductive surge by lightning), abuse, misuse, abnormal usage, faulty installation or improper maintenance.



This sensor detects Ultraviolet rays in the flames and initiates an alarm.  
It does not detect smoke, heat.

### Features

- **Choice of 2 spoken messages or alarm sound.**  
Message can be chosen from Japanese, English, Chinese, Korean, Spanish.
- **Power supply can be selected.**  
DC power by wire or Battery (Batteries are not included.)

## 1 Parts Description

### 1-1 Description

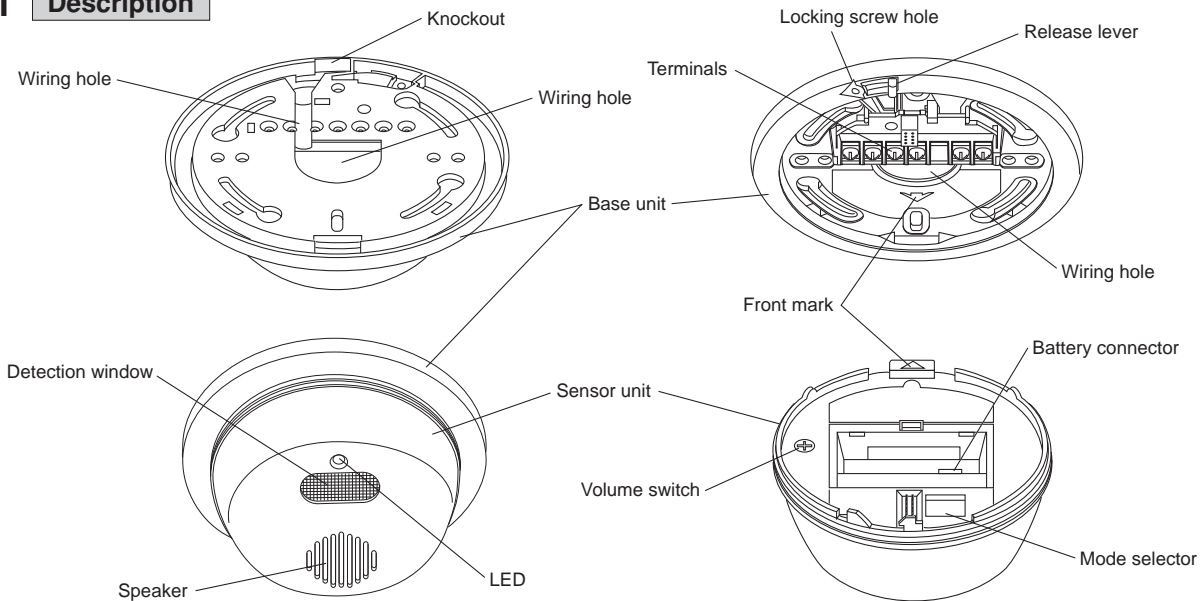

### 1-2 Accessory

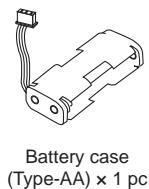
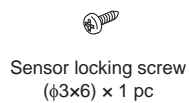
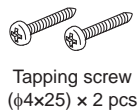

### 1-3 Mode setting

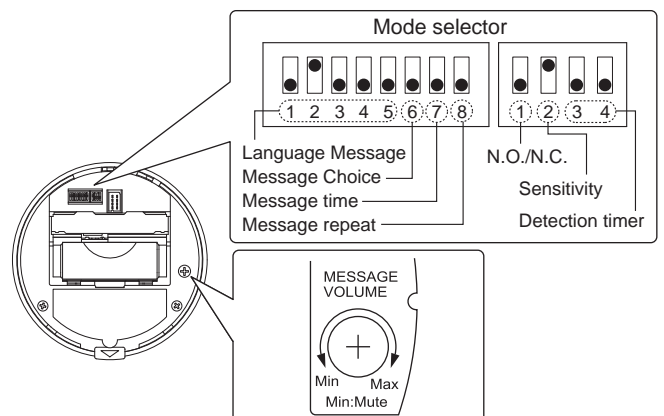

# 2 ATTENTION

## Description

 **Warning** If this is ignored, people could face the possibility of death or serious injury.

 **Notice** If this is ignored, people may suffer injury or personal property may suffer damages.

 This icon indicates actions to be avoided.

 This icon indicates instructions that should be strictly followed.

## Warning

 Do not modify the unit, it may cause fire or electric shock.

 Stop using the unit in case of strange smoke, smell, or noise generated from the unit.

 In case the water leaks into the unit, stop using the unit and power it off, contact the dealer.

 Do not install the unit in a location that cannot support its weight.

 Use the designated power voltage only.

 Do not mix old and new batteries.

 Do not touch the unit with wet hand.

 Do not recharge the included battery.

 When using batteries, ensure to keep the correct polarity.

 Do not heat, remodel the battery, do not put it into water, fire.

 Batteries are a choking hazard. Please keep away from children.

 Do not short-circuit the battery with the metal objects which may cause fire.

## Notice

 Avoid subjecting the unit to impact.

 This model is designed for indoor use only. Do not install outdoor.

 Use the designated battery only.

 Battery life may shorten depending on circumstances.

 Do not install the unit in a humid place.

 Do not install the unit in the following locations.

• Construction site where welding is done. The arc lamp of welding includes a very strong ultraviolet rays which reach flame sensors even indirectly by the reflection.



• Near the railway (Spark by pantograph)



• Near high voltage power line

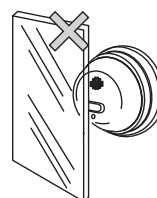

• In front of the object that intercepts light. (including glass and transparent resin)

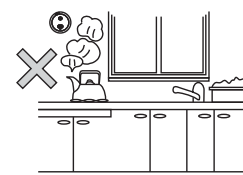

• In a site where fire is usually used such as a kitchen.

• In a site subject to direct or reflecting sunlight and rain. (This sensor is for indoor use only)

• Near any device which generates a strong magnetic field.

## ⚠ Caution

- ! Use designated battery only.
- ! Battery life may vary depending on usage and installation environment.
- ! The magnetism or magnetic field which this sensor emits will give some influence to the devices nearby. Check the situation prior to operation.
- ! \* Possible cause of false alarm. Do not install the sensor nearby the followings.
  - Halogen lamp
  - Electric discharging lamp such as mercury lamp
  - Electric sterilizer lamp
  - Spark from welding
  - Electric spark (Caused by motor, pantograph)
  - Sunlight
  - Lightning discharge
  - High voltage electric field
  - All objects which emit ultraviolet rays
- ! Although this unit is for indoor use, when it is installed in semi-outdoor, the location must be under eaves without sunshine and rain. Also it is recommended to set Detection timer longer than 3 sec. and Sensitivity "L".
- ! When the patient who carries isotope treatment comes near to detection area, Flame sensor may issue an alarm, in this case set detection sensitivity as "L".
- ! When the performance of the installed sensor is unstable and the cause cannot be specified, select Sensitivity "L" and detection time one step longer than current setting.
- ! When the sensor window is soiled by dust, oil, cigarette smoke, clean with soft cloth moistened with alcohol.
- ! \* Followings are not detected by flame sensor
  - Flames through glass or transparent resin
  - Lit portion of cigarette
  - Burning charcoal or briquet
  - Electric stove
  - Smouldering object

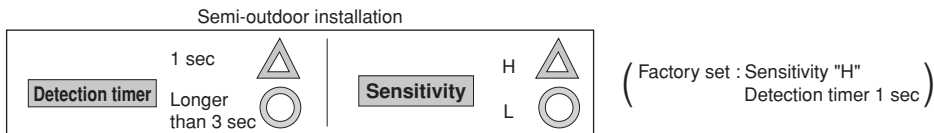

- ! This sensor is designed to detect ultraviolet rays in flames, and to output a warning message. This unit is neither fire detector nor heat detector nor smoke detector. TAKEX is not responsible for damage, injury or losses by fire, accident, calamity, Acts of God (Including inductive surge by lightning), abuse, misuse, abnormal usage, faulty installation or improper maintenance.
- ! This unit detects ultraviolet rays from a flame. At the same time it detects ultraviolet rays from other objects.
- ! This unit does not detect the objects which are burning without flame.
- ! Prior to the actual operation, adjust the detection area carefully and test the performance.
- ! Ultraviolet rays are sometimes reflected by walls or floors which causes unexpected detection resulting in a false alarm.

## 3 DETECTION AREA

- Detection area spreads out in front of the sensor at approx. 120° conically.

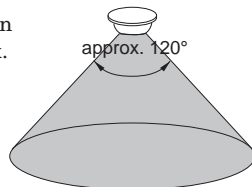

- The size of the detection area is in proportion to the size of the flame and detection time. Confirm the detection area using a lighter prior to actual operation.
- Use the optional BCW-401 universal bracket if area adjustment is required.

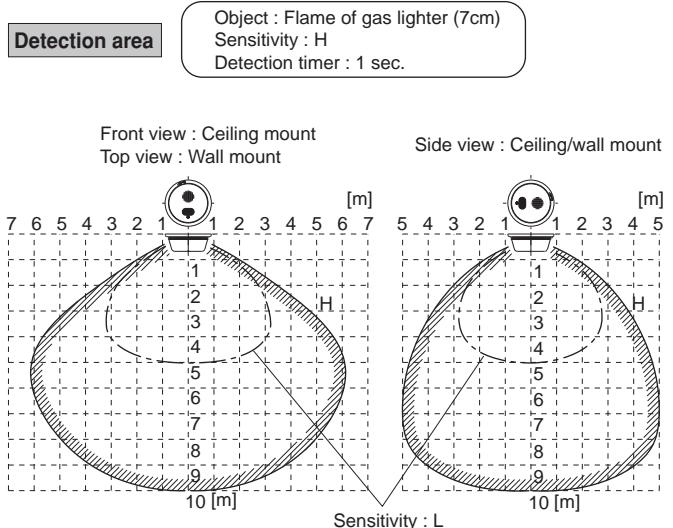

# 4 WIRING

## Terminal arrangement

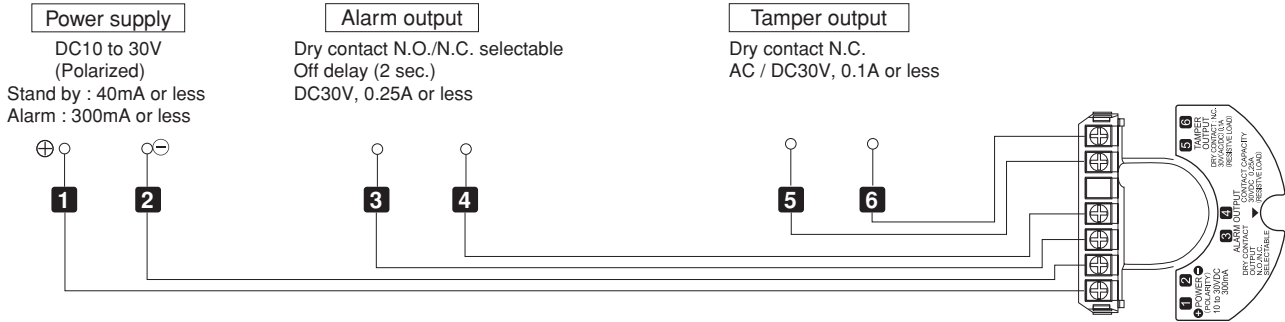

## Wiring distance

Between sensor and power supply

Size	DC12V	DC24V
φ0.65mm	50m	350m
φ0.90mm	100m	650m
φ1.20mm	150m	1200m
φ1.60mm	300m	2100m

### <<Notice>>

- In case connecting more than 2 sensors, the wiring distance is divided by the number of units.
- Signal line can be connected as far as 1,000m by φ0.65 OP wire.

## Wiring example

(2 sensors connected)

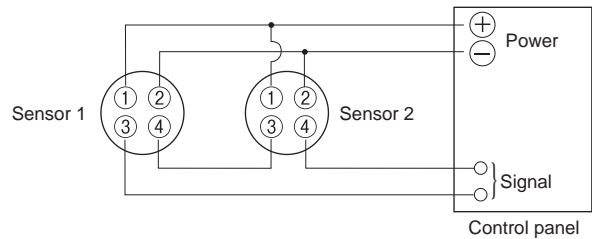

# 5 INSTALLATION

1 Locate the installation site

2 Slide the release lever to detach the sensor unit from the base.

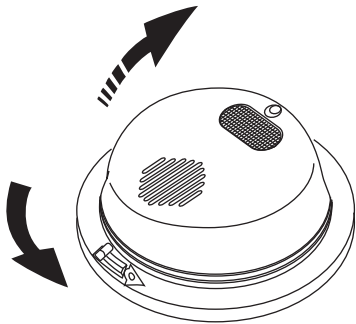

3 Fix the base with the screws included.

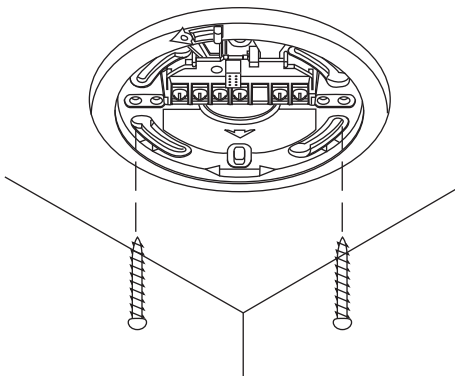

4 Arrange power supply by wire or by battery.

**By battery** (Batteries are not included.)

- Insert the battery into battery case with the correct polarity.
- Plug the connector of battery case into the main body and confirm the buzzer sound.
- Put the battery case into the main body.

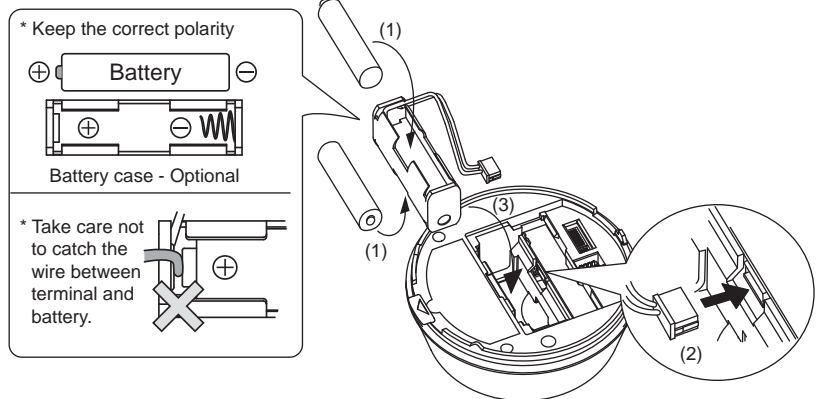

**By wiring**

- Connect the wire to the power terminal.

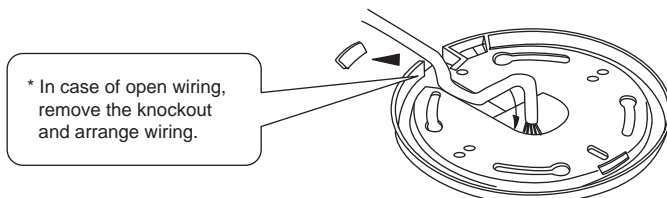

- 5** Choose message language, set detection timer and detection sensitivity and adjust message volume.
- 6** Attach the sensor unit to base unit.
- (1) Turn front marks of base unit and sensor unit to point in the same direction.
  - (2) Insert sensor unit into base unit.
  - (3) Push sensor unit until release lever is locked.

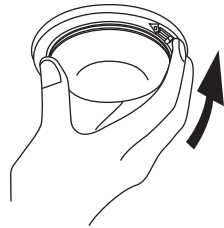
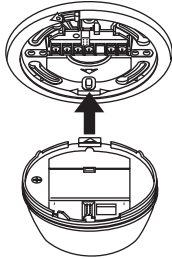

- 7** Check operation and area.

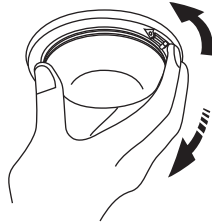

- 8** To detach the sensor unit, grip sensor as shown and slide the release lever.

- 9** To lock sensor unit, insert sensor locking screw into locking screw hole and tighten it.

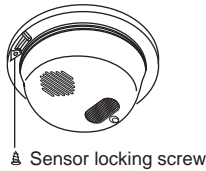

▲ Sensor locking screw

## [Installation of base]

This product is equipped with installation holes (Pitch 3.29" or 83.5mm) to make installation easy and sensor's direction adjustable.

### Installation hole

- (1) Place the base on the site and mark X on 2 points 180°

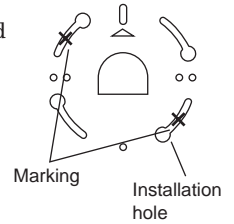

- (2) Drive the 2 pcs. of tapping screws (accessory) leaving 5mm exposed from the surface.

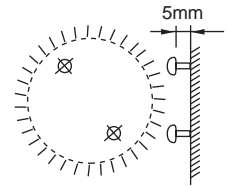

- (3) Adjust the sensor's direction by turning the base.



- (4) Tighten the screws.

# 6 FUNCTION

## (1) Operation

### Alarm (Basic action)

This product gives the following one-shot output only by detecting the flame continuing for the set time of detection timer.

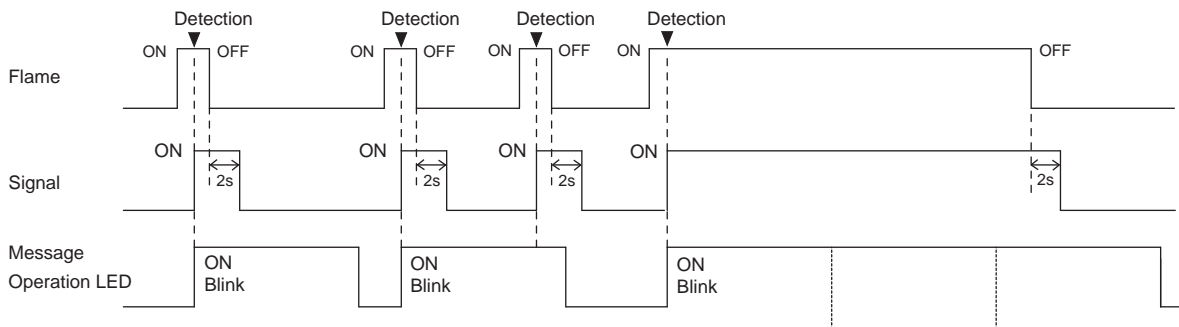

### Power on notice (Battery operation)

Power on notice will sound when the power is turned on. Speaker sounds intermittently 3 times. When voltage is low, power on notification will not be heard. Check the power supply.

### Low battery alarm

In case of low battery, LED flashes every 5 sec. In this case change the battery for new one immediately. Battery life is limited to 2 weeks after initial notification.

## (2) Function setting

### Volume setting

When volume switch is set to minimum, the volume will be mute.

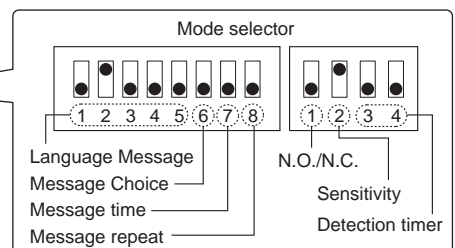
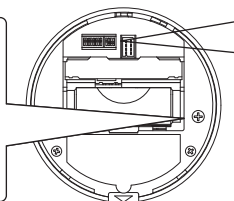
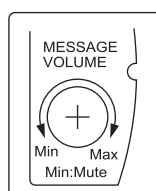

### Language selection

Message can be chosen among Japanese, English, Chinese, Korean, Spanish, or just buzzer sound. (Approx. 10 sec.).

Only chosen message by dip switch will be announced.

When no message chosen, only buzzer sound will be announced.

The order of announcement is Japanese → English → Chinese → Korean → Spanish which cannot be changed.

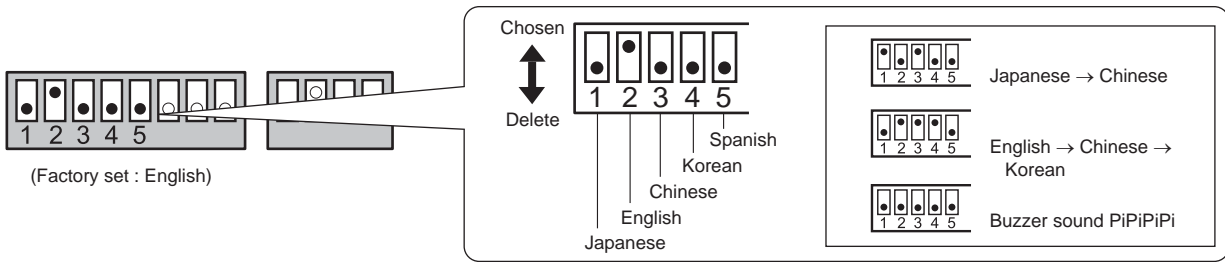

### Announcement choice

(Non-smoking) or (Fire prohibition) modes are available.

There are short and long message choices respectively.

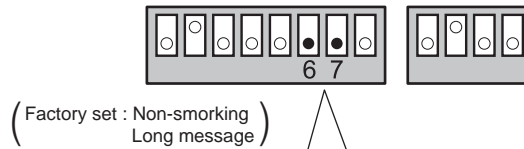

Announcement	Setting	Message
Non-smoking		<b>Long message</b> (1) JAP. [ここは禁煙です。お煙草はご遠慮ください。] (3.8s) (2) ENG. [This is a non-smoking area. Please refrain from smoking in this area.] (5.6s) (3) CHI. [这里是禁烟处。请不要抽烟。] (3.9s) (4) KOR. [여기는 금연 구역입니다. 담배는 삼가하시기 바랍니다. ] (5.0s) (5) SPA. [Prohibido fumar. Absténgase de fumar en el servicio.] (4.2s)
		<b>Short message</b> (1) JAP. [ここは禁煙です。] (1.8s) (2) ENG. [This is a non-smoking area.] (2.6s) (3) CHI. [这里是禁烟处。] (2.1s) (4) KOR. [여기는 금연 구역입니다。] (2.4s) (5) SPA. [Prohibido fumar.] (1.6s)
Fire prohibition		<b>Long message</b> (1) JAP. [ここは火気厳禁です。火気の使用はお断りいたします。] (4.9s) (2) ENG. [Open flame is prohibited. Please refrain from using open flame in this area.] (6.4s) (3) CHI. [此处严禁用火。请不要用火。] (4.1s) (4) KOR. [여기는 화기 엄금 구역입니다. 화기 사용을 금지합니다. ] (5.5s) (5) SPA. [Prohibido encender fuego. No se permite el uso de productos inflamables en el servicio.] (5.9s)
		<b>Short message</b> (1) JAP. [ここは火気厳禁です。] (2.2s) (2) ENG. [Open flame is prohibited.] (2.3s) (3) CHI. [此处严禁用火。] (2.2s) (4) KOR. [여기는 화기 엄금 구역입니다。] (3.2s) (5) SPA. [Prohibido encender fuego.] (2.1s)

### Message repeat

Can be set either once or twice.

\* This setting is for announcement only.

\* Choose all 5 languages, Fire-prohibition,

Twice setting will be 55 sec. long.

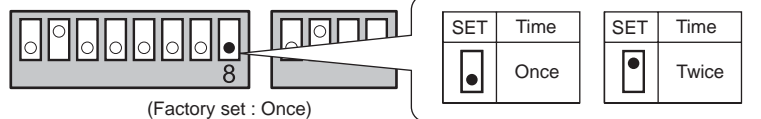

### Output contact

N.O./N.C. selectable.

Regardless of the setting, N.O. will be automatically chosen in case of battery operation.

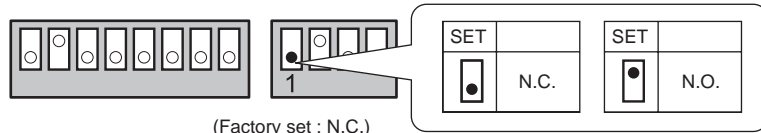



The following setting is about detection performance.

This unit detects ultraviolet rays in a flame and issues a signal.

In the semi-outdoors, there are many objects which generate ultraviolet rays and because there are no walls or windows in open area, there is a much higher possibility for the unit to detect those objects, in comparison with indoor installations.

The detection performance should be set using the dip switches according to the circumstances of the installation site.

When the performance of the installed sensor is unstable and the cause cannot be identified, select Sensitivity "L" and detection time one step longer than current setting.

### Sensitivity

Detection sensitivity is selectable H or L.

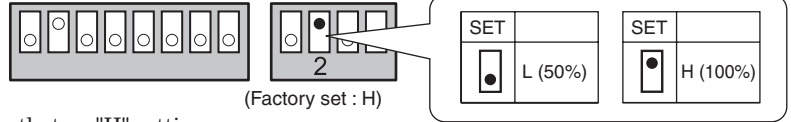

\* Detection distance on "L" setting is 50% shorter than that on "H" setting.

\* If the operation is unstable on "H", switch to "L".

\* When installed semi-outdoor, "L" setting is recommended.

### Detection timer

An alarm output occurs when the flame continues for set time of detection timer or longer.

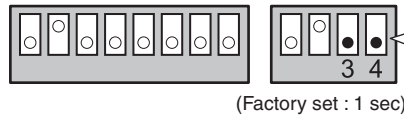

Detection time	Purpose/example
1 sec	• Immediate detection of flame of lighter/match at no-smoking area.
3 sec	• Fire detection
6 sec	• In case of unstable operation on the above
15 sec	• In the unfavourable circumstances of the site

SET	Timer
	1 sec
	3 sec
	6 sec
	15 sec

\* When the ultraviolet rays of flame are weak (it is related to size of flame and distance to the sensor), Alarm initiation may be delayed beyond the set time.

\* When installed semi-outdoor, set detection timer 3 sec or longer.

## 7 OPERATION CHECK

- 1 Turn power on. In case of battery operation, the buzzer "PiPiPi" sounds. In case of DC operated, no buzzer sounds.
- 2 Ignite a lighter etc. within detection area for more than the set time.

- 3 Warning message sounds intermittently and LED flashes.
- 4 After turning off the lighter, check if the output stops at the set up time. (When external output is used by wiring, a continuous output is issued during the above 3. and 4. alarm action. Confirm the operation of the connected devices.)

## 8 TROUBLE SHOOTING

Solve problems according to the following table. If normal operations cannot be restored by these corrective actions, contact either the dealer or TAKEX.

Trouble	Possible cause	Corrective action
Completely inactive	(1) No battery connected Low battery (2) No power supply (Broken wire or improper wire) Low voltage (When power supply wired) (3) Glass or transparent resin are interrupting the sensor (4) Sensor inside is wet by condensation etc.	(1) Connect battery Change battery (2) Correct wiring Adjust power voltage (3) Remove them (4) Dry out sensor inside, remove the cause of moisture
Sometimes inactive	(1) Improper area setting (2) Detection window is soiled with dust (3) Low battery (4) Low voltage	(1) Relocate the sensor to appropriate position or use BCW-401 (Optional) and adjust the angle (2) Clean with the soft cloth moistened with alcohol (3) Change battery (4) Correct power supply
Activated without flame	(1) Large electrical noise source such as a radio station or high-voltage wire nearby (2) Unexpected ultraviolet rays nearby (3) Sensor inside is wet by condensation etc.	(1) Relocate the sensor (2) Remove the origin of the ultraviolet rays, interrupt ultraviolet rays, or relocate the sensor. (3) Dry out sensor inside, remove the cause of moisture
The alarm LED flashes 5 sec./once	(1) Low battery	(1) Change the battery immediately
The alarm LED lights on but no sound from the speaker	(1) The volume switch is set at minimum (Mute)	(1) Adjust volume switch
The alarm LED and speaker work but the wire-connected devices are inactive	(1) Poor contact output connection or broken wire (2) Problem at panel	(1) Check the connection or wire (2) Check the connected panel

## Maintenance

- When low battery LED blinks, change battery for new one immediately. If it is left, it could cause inactiveness of the sensor.
- Check the operation once a week.

When detector elements are stained, spray alcohol to the elements and remove the stain. Do not use such chemicals as mild detergent, thinner or benzine to clean the detector elements. When housing is stained, clean it with a soft cloth.

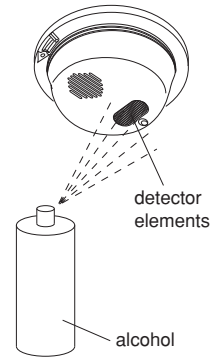

## 9 SPECIFICATIONS

Model	FLAME SENSOR WITH SPEAKER	
Model No.	FS-3500E (W)	FS-3500E (B)
Detection system	Ultraviolet Rays detection (185 to 260nm)	
Detection distance	10m (7cm flame)	
Angle	About 120°	
Sensitivity	Sensitivity 2 steps (H [100%], L [50%]) Detection timer 4 steps (1s, 3s, 6s, 15s)	
Power supply	<ul style="list-style-type: none"> <li>• Type-AA alkaline battery LR6 x 2 (3V)</li> <li>• External wiring DC10 to 30V (Polarized)</li> </ul>	
Battery life	Type-AA alkaline battery ... approx. 2 years Lithium battery ... approx. 5 years	
Power consumption (DC Power)	Stand-by : 40mA or less Alarm : 300mA or less	
LED	Indication : RED Alarm : Flash during message output Low battery : Flash 0.1 sec every 5 sec	
Message	<ul style="list-style-type: none"> <li>• 5 language message Non-smoking</li> <li>(1) JAP. [ここは禁煙です。お煙草はご注意ください。]</li> <li>(2) ENG. [This is a non-smoking area. Please refrain from smoking in this area.]</li> <li>(3) CHI. [这里是禁烟处。请不要抽烟。]</li> <li>(4) KOR. [여기는 금연 구역입니다. 담배는 삼가하시기 바랍니다.]</li> <li>(5) SPA. [Prohibido fumar. Absténgase de fumar en el servicio.]</li> </ul> <p>Fire prohibition</p> <li>(1) JAP. [ここは火気厳禁です。火気の使用はお断りいたします。]</li> <li>(2) ENG. [Open flame is prohibited. Please refrain from using open flame in this area.]</li> <li>(3) CHI. [此处严禁用火。请不要用火。]</li> <li>(4) KOR. [여기는 화기 엄금 구역입니다. 화기 사용을 금지합니다.]</li> <li>(5) SPA. [Prohibido encender fuego. No se permite el uso de productos inflamables en el servicio.]</li> <p>Buzzer sound</p> <li>(1) [PiPiPiPi...]</li> <ul style="list-style-type: none"> <li>• Long/Short message selectable</li> <li>• Message repeat : Once/twice selectable</li> <li>• Volume : Mute - Max.80dB (1m from the sensor)</li> </ul>	
Output	Relay contact output N.O./N.C. selectable Detection time plus 2 sec. Output DC30V, 0.1A	
Tamper	Relay contact output N.C. is issued when the sensor unit is detached from the base unit AC/DC30V, 0.1A	
Wiring	By terminals	
Ambient temperature	-10°C to +60°C without condensation (Battery performance may decrease under 0°C or beyond 40°C)	
Installation	Indoor	
Weight	230g (Including 50g battery)	
Appearance	ABS resin (white)	ABS resin (brown)

## 10 DIMENSIONS (mm)

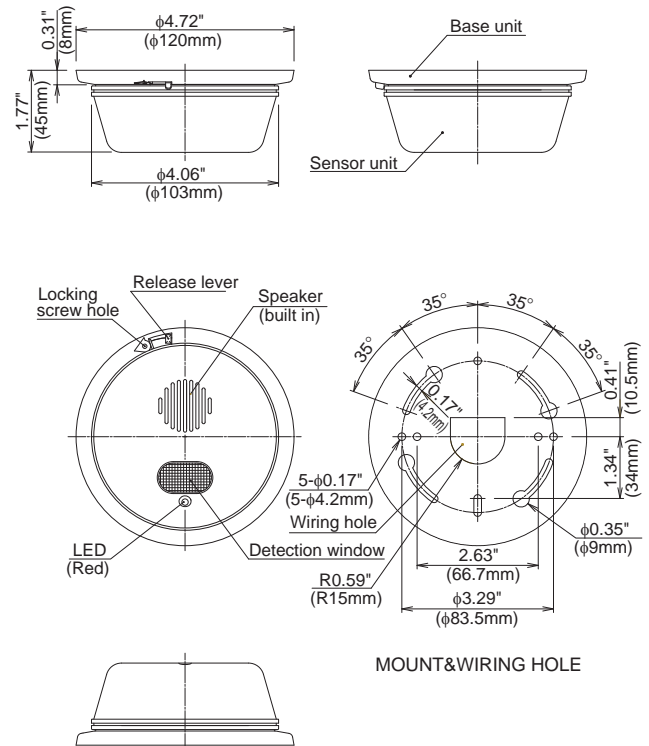

## OPTIONALS

- Ceiling/wall mount attachment (BCW-401)
- The recorded message can be changed to custom order.

### Limited Warranty :

TAKEX products are warranted to be free from defects in material and workmanship for 12 months from original date of shipment. Our warranty does not cover damage or failure caused by Acts of God (including inductive surge by lightning), abuse, misuse, abnormal usage, faulty installation, improper maintenance or any repairs other than those provided by TAKEX. All implied warranties with respect to TAKEX, including implied warranties for merchantability and implied warranties for fitness, are limited in duration to 12 months from original date of shipment. During the Warranty Period, TAKEX will repair or replace, at its sole option, free of charge, any defective parts returned prepaid. Please provide the model number of the products, original date of shipment and nature of difficulty being experienced. There will be charges rendered for product repairs made after our Warranty period has expired.

## TAKEX TAKENAKA ENGINEERING CO., LTD.

In Japan  
**Takenaka Engineering Co., Ltd.**  
 83-1, Gojo-sotokan,  
 Higashino, Yamashina-ku,  
 Kyoto 607-8156, Japan  
 Tel : 81-75-501-6651  
 Fax : 81-75-593-3816  
<http://www.takex-eng.co.jp/>

In the U.S.  
**Takex America Inc.**  
 3350, Montgomery Drive,  
 Santa Clara,  
 CA 95054, U.S.A  
 Tel : 408-747-0100  
 Fax : 408-734-1100  
<http://www.takex.com>

In Australia  
**Takex America Inc.**  
 4/15 Howleys Road, Notting Hill,  
 VIC, 3168  
 Tel : +61 (03) 9544-2477  
 Fax : +61 (03) 9543-2342

In the U.K.  
**Takex Europe Ltd.**  
 Takex House, Aviary Court, Wade Road,  
 Basingstoke, Hampshire, RG24 8PE, U.K.  
 Tel : (+44) 01256-475555  
 Fax : (+44) 01256-466268  
<http://www.takexeurope.com>